



## EWN-Y Series Electromagnetic Metering Pumps

The EWN-Y Series electronic metering pumps offer superior high speed dosing capability with more standard features. The flexibility of the EWN-Y pump enable it be integrated into virtually any chemical feed application using a universal-voltage, digital controller with an expanded set of control features. Superb valve performance and advanced solenoid engineering combine to make a highly precise pump for the most demanding applications.

EWN pumps have outputs to 6.7 GPH (25.2 L/h) and a maximum pressure of 290 PSI (20 bar). The high speed of operation results in high resolution chemical feed and long service life. Quiet and compact, the EWN pumps prime in seconds and hold prime reliably.



### > High Speed Performance

E-Series pumps operate up to 360 strokes-per-minute with adjustments in 1 spm increments, providing high resolution chemical feed. Adjustable stroke length further increases the ability to refine the output, making the E-Series one of the most versatile solenoid metering pumps on the market.

### > Multi-function Digital Controller

The controller in the EWN-Y pump provides for flexible pump control including scalable Analog control, Digital Input with Multiply and Divide capability, external stop control, batch control, auto output control with the EFS sensor, and basic speed/stroke length control. Display can be adjusted between flow rate units or % speed for easy-to-read output and quick adjustment. The controller is universal voltage so it can be used anywhere in the world.

### > Engineered Longevity

All E-Series pumps feature dual bearing support. The armature and shaft are supported with a bearing on each end, which ensures proper axial movement, enabling the E-Series to operate at 360 SPM while extending the life of the diaphragm.

### > Superior Check Valve Performance

Dual Check Valve Assemblies in both suction and discharge fittings feature precision ball guides and tapered seats. Precise machining and molding of parts limit valve ball travel, ensuring that balls fully seat and seal with every stroke. This superior check valve design guarantees fast priming and reliable performance.

### > Flexible Connections

A removable tubing insert provides flexibility of tubing sizes and eliminates twisting of the tubing during connection. A threaded insert can be used in place of the tubing adapter to easily convert any connection to NPT.

### > High Compression Ratio

The compression ratio of a metering pump is important because it affects the pump's ability to prime and vent. The compression ratio is raised when you reduce the dead volume of the pump head during operation. All E-Series pumps feature a very high compression ratio that ensures proper feed especially with off-gassing products (i.e. Sodium Hypochlorite).



# Specifications

## Model Identification

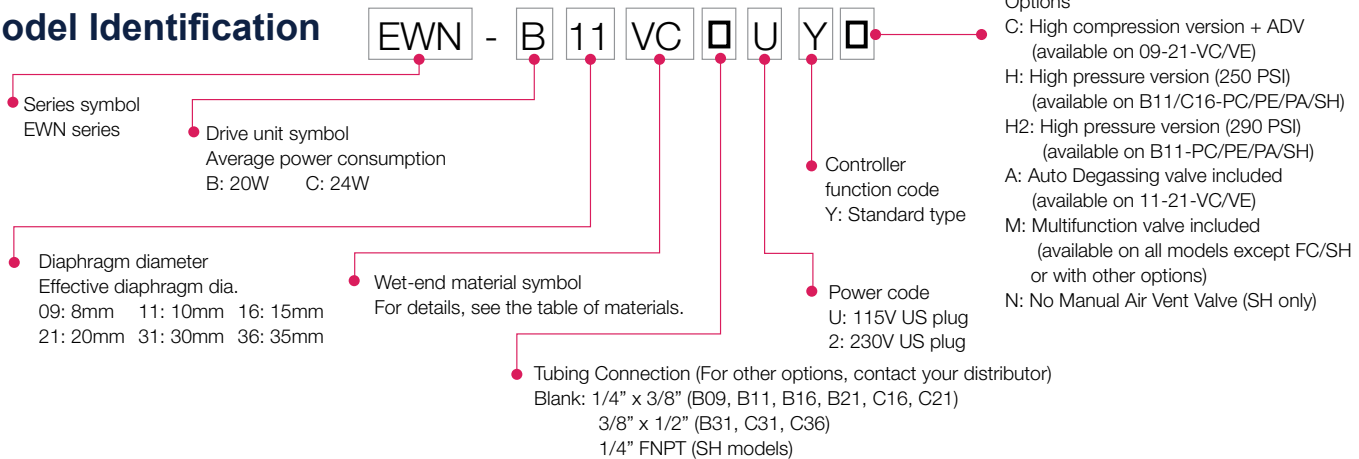

## Wet End Materials

	Pump Head	Diaphragm	Valve Balls	Valve Seat	O-ring Seal	Gasket
VC	PVC	PTFE +EPDM	CE	FKM	FKM	PTFE
VE				EPDM	EPDM	
VF			PTFE	EPDM	EPDM	
PC	GFRPP		CE	FKM	FKM	
PE				EPDM	EPDM	
PA				PCTFE	AFLAS®	
FC	PVDF			PCTFE	PTFE	
TC	PVC		CE	FKM	FKM	
TA				PCTFE	AFLAS®	
SH	316SS		HC	316SS	PTFE	

CE	Alumina ceramic	EPDM	Ethylene propylene diene monomer
FKM	Fluoroelastomer	GFRPP	Glass fiber reinforced polypropylene
PTFE	Polytetrafluoroethylene	PVC	Polyvinylchloride (translucent)
PCTFE	Polychlorotrifluoroethylene	HC	Hastelloy C276
PVDF	Polyvinylidene fluoride	316SS	316 Stainless Steel

## Shipping weight

EWN-B: 10 lbs (4.5 kg)  
EWN-C: 12 lbs (5.5 kg)  
\*SH liquid ends increase weight up to 50%

## Electrical Specifications

EWN	EWN-B	EWN-C
50/60 Hz, 1 phase	20 Watt avg.	24 Watt avg.
100-240VAC ±10%	0.8 Amp max.	1.2 Amp max.

## Safety Certifications

The EWN series metering pumps\* are WQA tested and certified to NSF/ANSI/CAN Standard 61.  
\* See [www.wqa.org](http://www.wqa.org) for specific chemicals and certification parameters.



The EWN series metering pumps are tested by Intertek to UL and CSA standards.



## Pump Specifications (Standard pumps and pumps with MFV)

Model		B11	B16	B21	B31	C16	C21	C31	C36	
									VC/VE/PC/PE	FC/SH/TC
Max. Output Capacity	GPH	0.6	1.0	1.6	3.2	1.3	2.1	4.3	6.7	6.5
	mL/min	38	65	100	200	80	130	270	420	410
	mL/shot	0.02-0.11	0.04-0.18	0.06-0.28	0.11-0.56	0.04-0.22	0.07-0.36	0.15-0.75	0.23-1.17	0.23-1.14
Rated discharge pressure	PSI	150	105	60	30	150	105	50	30	30
Max pressure	PSI	203	116	73	30	174	116	50	30	30
Stroke rate	% (spm)	0.1 to 100 (1 to 360)								
Stroke length rate	% (mm)	20 to 100 (0.2 to 1.0)				20 to 100 (0.25 to 1.25)				

Note 1: Max. output capacity shown is at **Rated Discharge Pressure** (stroke length 100%, stroke rate 100%) and increases as a discharge pressure reduces.

Note 2: Max pressure rating is the maximum useable capability of the pump. Max. output capacities may be lower than published at pressures higher than Rated Discharge Pressure. Max. pressure of PVC type is 174 PSI. Please contact your distributor for more information.

Note 3: The performance is based on pumping clean water at ambient temperature at rated discharge pressure and voltage.

Note 4: Liquid temperature: PVC liquid ends: 14 to 104°F (-10 to 40°C) GFRPP/PVDF/SS liquid ends: 14 to 140°F (-10 to 60°C)

Note 5: Ambient temperature: 32 to 122°F (0 to 50°C) Relative humidity: to 85% (non-condensing)

Note 6: All pumps include a manual air vent valve except FC/SHN/HV models. All pumps include one foot valve, injection valve, 20 ft. of PE tubing and ceramic weight except for SH/H2/HV models.

# Construction

## Standard Model

Standard pumps have a Manual Air Vent Valve enabling easy priming, quick release of pressure and draining of the discharge line. An optional Multi-Function Valve can replace the standard air vent valve, adding back pressure and anti-siphon protection as well as automatic pressure relief.

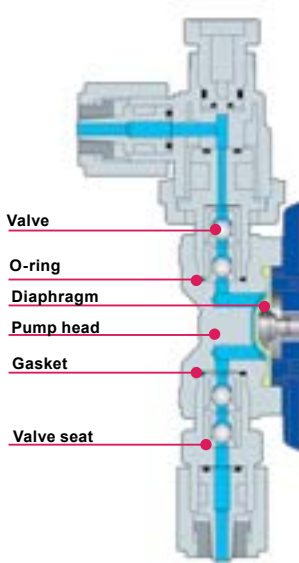

## Auto Degassing Valve Model

Chemicals that outgas, such as Sodium Hypochlorite or Hydrogen Peroxide, can generate enough gas to gas lock metering pumps. Using a dual check valve system, the Auto Degassing Valve vents any gas to atmosphere to eliminate gas lock conditions and keep the pump primed.

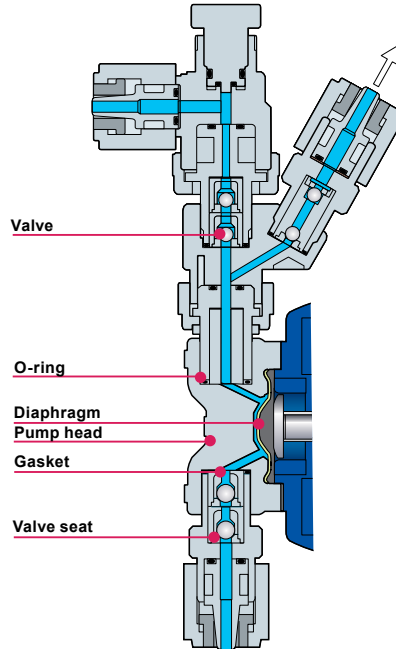

## High Compression Model

Increasing the compression ratio by minimizing dead volume in the liquid end combined with the auto degassing valve further helps to eliminate gas in the pump heads. In addition to reducing air lock conditions, the increased compression ratio helps with accuracy at low output ranges.

## High Pressure Model

The high pressure models are capable of operating at flow rates up to 0.6GPH (40mL/min) at a maximum discharge pressure up to 290PSI. This makes it suitable for applications such as chemical injection into boiler make-up water.

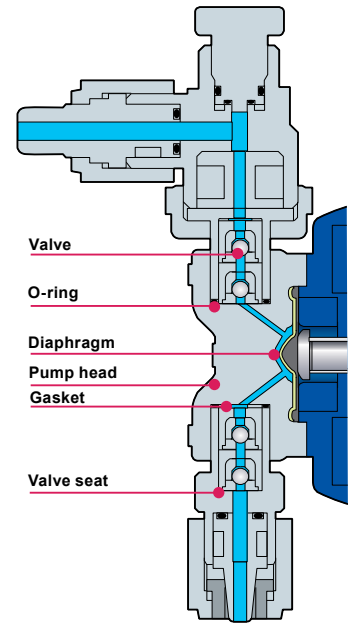

### Wet-end materials (Special versions)

Material code	Auto Degassing Valve		High Compression Models		High Pressure Models		
	VC-A	VE-A	VC-C	VE-C	PC-H	PE-H	SH-H
Pump head	PVC		PVC		GFRPP		SUS316
Valve	CE		CE		CE		HC
Valve seat	FKM	EPDM	FKM	EPDM	FKM	EPDM	SUS316
Gasket	PTFE		PTFE		PTFE		
O-ring	FKM	EPDM	FKM	EPDM	FKM	EPDM	—
Diaphragm	PTFE+EPDM		PTFE+EPDM		PTFE+EPDM		

### Specifications (Special versions)

Model	Auto Degassing Valve						High Compression Models (ADV included)						
	B11	B16	B21	C16	C21		B09	B11	B16	B21	C16	C21	
Max. Output Capacity	GPH	0.5	0.9	1.4	1.0	1.7	0.2	0.4	0.6	1.0	0.9	1.2	
	mL/min	30	55	86	65	110	12	23	40	63	54	78	
Rated Discharge Pressure	PSI	150	105	60	150	105	150	150	105	60	150	105	
	mL/shot	0.02 - 0.08	0.03 - 0.15	0.05 - 0.24	0.04 - 0.18	0.06 - 0.31	0.01 - 0.07	0.03 - 0.13	0.04 - 0.22	0.07 - 0.35	0.06 - 0.30	0.09 - 0.43	
Stroke Rate	% (spm)	0.1 - 100 (1-360)						0.1 - 100 (1-180)					
Stroke Length Range	% (mm)	20 - 100 (0.2 - 1.0)				20 - 100 (0.25 - 1.25)		20 - 100 (0.25 - 1.25)				20 - 100 (0.3 - 1.50)	

Model	High Pressure Models		High Pressure Models (290 psi)
	B11	C16	B11
Max. Output Capacity	GPH	0.4	0.3
	mL/min	25	17
Rated Discharge Pressure	PSI	250	290
	mL/shot	0.02 - 0.1	0.03 - 0.17
Stroke Rate	% (spm)	0.1 - 100 (1-240)	
Stroke Length Range	% (mm)	20 - 100 (0.2 - 1.0)	70 - 100 (0.5 - 0.9)

Note 1: Max. output capacity shown is at **Rated Discharge Pressure** (stroke length 100%, stroke rate 100%) and increases as a discharge pressure reduces.  
 Note 2: The performance is based on pumping clean water at ambient temperature at rated voltage.

### Input/Output Connectors:

E90495 5-pin connector: Use for Analog, Pulse, Interlock, AUX & Batch S/S inputs & Analog Output. (Supplied with pump)

E90496 5-pin reverse key connector: Use for Stop & Pre-Stop inputs. Also for PosiFlow or FCM input (Sold separately)

E90497 4-pin square connector: Use for relay outputs (Sold separately)

# Specifications

## Controller Specifications

Model		EWN-Y	
Operational mode	Auto control	Feedback control	0.1 to 999.9mL/min 0.001 to 59.994 L/H 0.001 to 15.829 GPH
	EXT control	Analog rigid	4 to 20, 20 to 4, 0 to 20, 20 to 0mA proportional control to stroke rate
		Analog variable	2 - point setting (Analog variable) (Proportional control to flow/stroke rate in the range of 0-20mA)
		BATCH	0.1 to 99999.9 mL 0.001 to 99.999 L 0.001 to 26.385 G
Display	LCD	14seg-5digits backlit LCD Operating conditions and Flow rate etc	
	LED	ON	A 2-color LED lights in orange when turning on power and in green during operation.
		STOP	A 2-color LED lights in red when receiving the STOP signal and in orange when receiving the PreSTOP signal.
OUT		A LED lights in red when the pump is transmitting a signal to external devices.	
Keypad	5 keys	START/STOP, EXT, ▲(UP), ▼(DOWN), Disp	
Control function	STOP/Pre-STOP	Pump keeps running when Pre-STOP is activated. Pump stops when STOP is activated.*1	
	Prime	Pump runs at max. stroke rate while up and down keys are pressed.	
	Key lock	Keypad can be locked and unlocked.	
	Inter lock	Operation stop at contact input*1	
	Reading calibration	Reading adjustment of flow volume per shot	
	Buffer	ON/OFF of the batch control buffer memory	
Input	Pulse signal input for batch control	No voltage contact or open collector*2	
	Analog	0 to 20mADC (Input resistance is 220Ω.)	
	STOP/Pre-STOP (Level sensor)	No voltage contact or open collector*2	
	AUX	No voltage contact or open collector*2	
	Interlock	No voltage contact or open collector*2	
	Batch	No voltage contact or open collector*2	
Output	OUT1	No voltage contact (Mechanical relay), 250VAC 3A (Resistive load) Either the Signal recognition output*3, Control error, or Poor flow detection is selectable (default: STOP).	
	OUT2	No voltage contact (PhotoMOS relay), AC/DC24V 0.1A Either the Sensor signal output, Synchronous output, Signal recognition output*3, Control error or Poor flow detection is selectable.	
	Analog	4 to 20mA DC (Allowable load resistance : 500Ω)	
Data logging	Total flow volume Total number of strokes (1=1000 shots) Total number of signal outputs (OUT1) Total number of signal outputs (OUT2) Total power connection time Total operating time		
Buffer memory	Nonvolatile memory		
Power voltage*4	100 to 240VAC 50/60Hz		

Note 1: The setting can be changed to "operation starts with contact closure".  
 Note 2: The maximum applied voltage from the pump to an external contact is 12V at 2.3mA. When using a mechanical relay, its minimum application load should be 1mA or below.  
 Note 3: STOP/ Pre-STOP/ Interlock/ Batch completion outputs are independently enabled.  
 Note 4: Observe the specified power voltage range. Otherwise failure may result. The allowable power voltage range is 90 to 264VAC

## Dimensions (in inches)

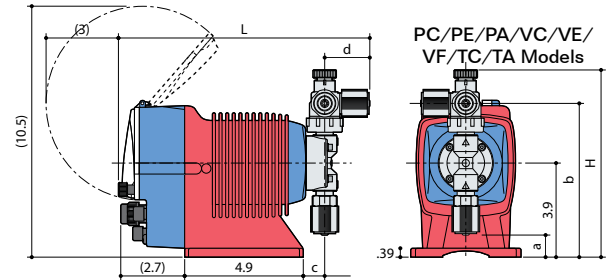

Bottom View

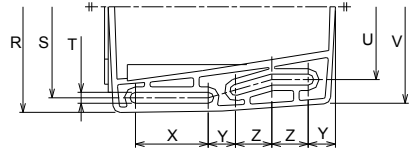

## Mounting Dimensions

EW Model	R	S	T	U	V	X	Y	Z
11, 16, 21	4.57	3.94	0.24	3.15	4.17	1.57	0.59	0.79
31, 36								

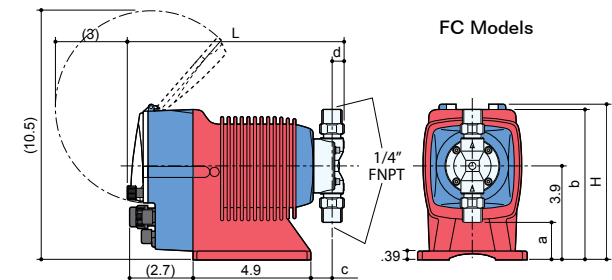
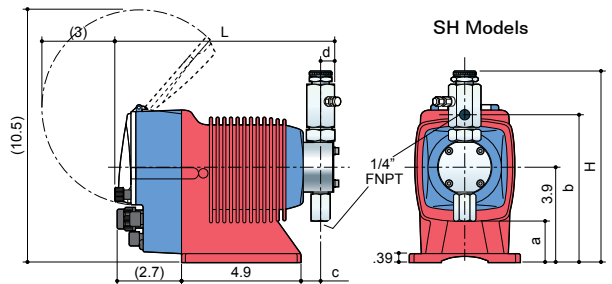

Material	EWN-Y Model	H	L	a	b	c	d
PC/PE/PA VC/VE/VF TC/TA	11, 16, 21	7.83	10.43	0.94	6.45	0.90	1.85
	31	8.34	10.51	0.23	6.97	0.98	1.89
	36	8.30	10.51	0.27	6.93	0.94	1.89
SH	11, 16, 21	7.91	9.13	1.73	6.10	0.86	0.59
	31	8.38	9.17	1.34	6.49	0.90	0.59
	36	8.50	9.17	1.26	6.69	0.90	0.59
FC	11, 16, 21	6.53	9.09	1.57	6.31	0.90	0.51
	31	6.97	9.29	0.90	6.97	0.98	0.63
	36	6.97	9.25	0.90	6.97	0.94	0.63

180667.E March 2021

**WALCHEM**  
IWAKI America Inc.