



PDS100 Programmable Dispensing System

INSTRUCTION MANUAL

SAFETY INSTRUCTIONS



Before using any Fluid Metering, Inc. product read the following safety instructions as well as specific product specifications and operating instructions.



Warning! Fire, electrical shock or explosion may occur if used near combustibles explosive atmosphere, corrosive air, wet environment or submerged in fluid.

- Turn off the electrical power before checking pump for any problems.
- Connect motor, speed controllers, or any other electrical devices based on Fluid Metering Inc. specifications. Any unauthorized work performed on the product by the purchaser or by third parties can impair product functionality and thereby relieves Fluid Metering, Inc. of all warranty claims or liability for any misuse that will cause damage to product and/or injury to the individual.
- Power cables and leads should not be bent, pulled or inserted by excessive force. Otherwise there is a threat of electrical shock or fire.
- Replace any inline fuses only with fuse rating as specified by Fluid Metering, Inc.
- When pump/drive is under operation, never point discharge tubing into face or touch any rotating components of pump.
- In a power down thermal overload cut-in condition, unplug or turn off power to pump. Always allow a cool down period before restarting: otherwise, injury or damage may occur.
- For 30 seconds after power is removed from pump/drive: do not touch any output terminals. Electrical shock may occur because of residual voltage.



Caution! Fire, electrical shock, injury and damage may occur if not used in accordance with Fluid Metering, Inc. specifications and operation instructions.

- Do not put wet fingers into power outlet of unit.
- Do not operate with wet hands.
- Do not operate drive assemblies that require a hard mount (to be bolted down) unless they are mounted per Fluid Metering, Inc. specifications, if not injury may occur and/or damage to unit.
- Do not touch any rotating pump or motor components: injury may occur.
- Do not run pump dry, unless designed for that service. Running dry is harmful to the pump, and will cause excessive heating due to internal friction.
- Check pump rotation and inlet/outlet pump port orientation before connecting power to pump. If not injury may occur.
- When pulling out cords from outlets do not pull cord, grasp plug to prevent plug damage or electrical shock.
- Fluid Metering, Inc. Drive Motors become HOT and can cause a burn. **DO NOT TOUCH!**

OVERVIEW

The PDS100 is a precision system capable of dispensing or pumping fluids ranging from 5 μ L per dispense or 15 μ L/min continuous (Single RH00LF) up to 1536 mL/min (Dual Q3) into pressures ranging from 10 psi (Q3) to 100 psi (RH). The PDS100 offers single, dual (in phase, out of phase and independent) pump head control. PDS100 offers RS485 communications, which allows the user to control the PDS100 via a PC or PLC. Dry contact inputs offer an easy method to start and stop the pumps through the use of a simple switch. The PDS100 also offers inputs which provide control of the dispense rate via a 0 – 10 VDC, 0 –5 VDC or 4–20 mA input.

A simple easy to use local keypad provides the user access to local control of the pump or pumps and a vivid display to provide user-friendly menus for ease of control.



Power Up Screens (two individually controlled pumps)

This is what will be seen on power up when the unit is configured for individually controlled pumps (factory default). For Single pump configured system use "Pump A" screens only.

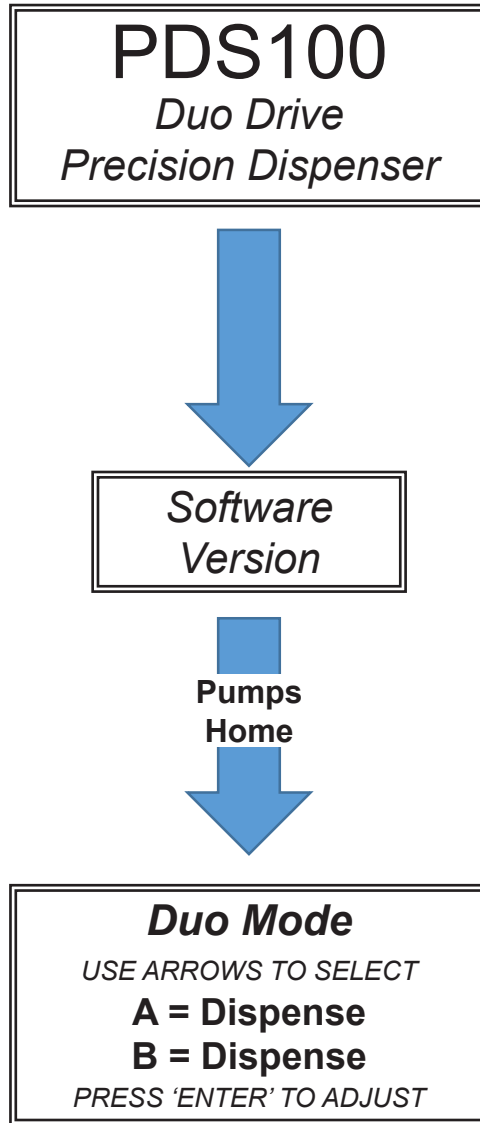





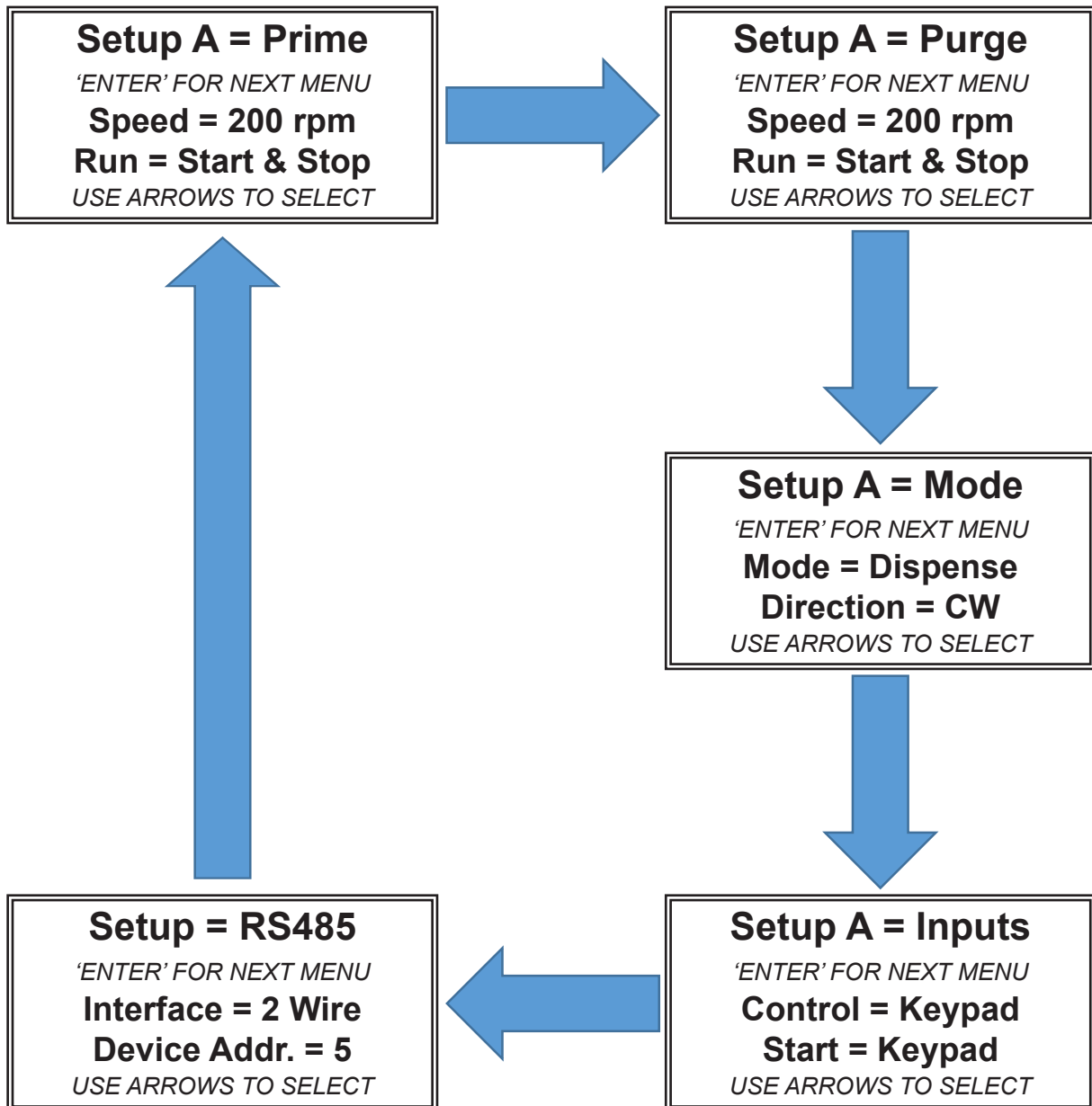

Figure 4
Pump A & Pump B Location

Setup Screens (two individually controlled pumps) Prime / Purge, Mode & Input Setup Screens

To select “**Prime / Purge, Mode & Input Setup**” screen wait for the pumps to home then press the up  up /down arrow to select desired pump (A or B: see figure 4) and then press the Setup  button. The following screens are available. Pressing  enter will go to each screen. Pressing the up  or down  arrow will select additional items.

Factory default values shown



Only appears if RS485 is selected for Control mode and/or Start mode on previous (Inputs) screen

Setup Screens (two individually controlled pumps) cont'd: Prime / Purge Adjust and Activation











Prime and Purge have the following available settings

Factory default values shown

Setup A = Prime
'ENTER' FOR NEXT MENU
Speed = 200 rpm
Run = Start & Stop
USE ARROWS TO SELECT

Setup A = Purge
'ENTER' FOR NEXT MENU
Speed = 200 rpm
Run = Start & Stop
USE ARROWS TO SELECT

- **Speed** (7 – 749 rpm for the STH & RH and 7 – 599 rpm for the STQ & STQP)
- **Run**
 1. **Run = “Start & Stop”**. Start prime / purge via keypad “Run” and stop prime / purge via “Stop”
 2. **Run = “Ext. Switch”**. Start prime / purge via external switch. Pump will continue to prime / purge until switch is released. Switch A activates pump A and Switch B activates pump B.
 3. **Run = “Start & Hold”**. Start prime / purge via keypad “Run”. Prime / purge will continue until the Run button is released.

To adjust either the speed or run method simply press the up  or down  arrow keys to go to the desired item and then press the enter  key to select. To set the speed press the up / down   arrow keys until the desired speed is shown. Press enter  key to save. To set the desired run method press the up / down   arrow keys until the desired run method is shown. Press enter  key to save. To start the Prime / Purge process use the device chosen (Keypad run button or external switch). To exit setup, press the setup  key and the motor(s) will automatically home or press the enter  key to go to the next setup screen.







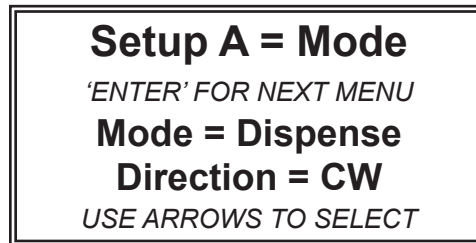



Setup Screens (two individually controlled pumps) cont'd: Mode and Direction Adjust

Mode has the following available settings for direction.

Factory default values shown



- **Mode**
 1. **Continuous** Pump will run until a Stop command is given.
 2. **Dispense** Pump will run until a Stop command is given or the programmed dispenses is reached
- **Direction**
 1. **CW**
 2. **CCW**



To adjust either the mode or direction simply press the up  or down  arrow keys to go to the desired item and then press the enter  key to select. To set the mode, press the up / down   arrow keys until the desired mode is shown. Press enter  key to save. To set the desired direction, press the up / down   arrow keys until the desired direction is shown. Press enter  key to save. To exit setup, press the setup  key and the motor(s) will automatically home or press the enter  key to go to the next setup screen.











Setup Screens (two individually controlled pumps) cont'd: Control and Start Method

Input has the following available settings for Input Control Type and Start Method

Factory default values shown

Setup A = Inputs
'ENTER' FOR NEXT MENU
Control = Keypad
Start = Keypad
USE ARROWS TO SELECT

- **Control (Speed)** Speed can be adjusted prior to run command from one of the following 5 options listed below:
 1. **RS485**
 2. **4-20 mA**
 3. **0-10 V. (VDC)**
 4. **0-5 V. (VDC)**
 5. **Keypad** The pump speed can be adjusted via the keypad up/down arrow keys.
- **Start** The pumps can be activated (started) from one of the following 5 options listed below:
 1. **RS485**
 2. **Analog** Pump(s) will start when a voltage is applied to the pump(s) Analog Input(s) based on Table 2, pg. 12.
 3. **Power Up** The pumps will start to dispense / meter after power is applied. Note: The pumps initially "home" prior to starting the dispense / metering process. In dispense mode the pumps will stop rotating once the desired dispense count is reached. The keypad stop button can also activate a stop command.
 4. **Switch** Momentary closure will activate a pump in dispense mode. In continuous mode the pumps will only rotate while the switch is closed. Upon switch removal the pumps will complete rotating until "home" is reached.
 5. **Keypad** The pump will start when the keypad start  key is pressed, and stop when the stop  key is pressed.

To adjust either the control method or start method simply press the up  or down  arrow keys to go to the desired item and then press the enter  key. To set the control method, press the up / down   arrow keys until the desired control method is shown. Press enter  key to save. To set the start method, press the up / down   arrow keys until the desired start method is shown. Press enter  key to save. To exit setup, press the setup  key and the motor(s) will automatically home or press the enter  key to go to the next setup screen.







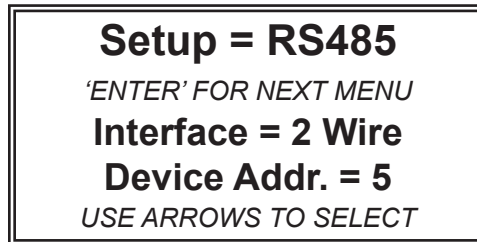



Setup Screens (two individually controlled pumps) cont'd: RS485 Setup

RS485 has the following available settings for Interface & Device Addresses

Factory default values shown



- **Interface** 2 wire or 4 wire
- **Device Address** Up to 31 (address #1 to #31) units can be independently addressed.

To adjust either the interface type or device address, simply press the up  or down  arrow keys to go to the desired item and then press the enter  key to select. To set the interface type press the up / down   arrow keys until the desired control method is shown. Press enter  key to save. To set the Device Address press the up / down   arrow keys until the desired address is shown. Press enter  key to save. The address selected applies to both pumps in a dual pump system. To exit setup, press the setup  key and the motor(s) will automatically home or press the enter  key to go to the next setup screen.

Main Screen (both pumps in Dispense mode):
Speed / Strokes adjust via keypad

Duo Mode
USE ARROWS TO SELECT
A = Dispense
B = Dispense
PRESS 'ENTER' TO ADJUST













Press the up / down   arrow keys, then the enter  key to adjust the desired pump

A = Dispense
USE 'ENTER' WHEN FINISHED
Speed = 200 rpm
Strokes = 10
USE ARROWS TO ADJUST

Speed can be adjusted based on the control type selected from the Input Setup section in the manual. By default the PDS100 is configured for Keypad Control and Keypad Start.

A = Dispense
USE 'ENTER' WHEN FINISHED
Speed = 200 rpm
Strokes = 10
USE ARROWS TO ADJUST

To adjust the speed, press the up arrow  key and then press the enter  key. Press the up / down   arrow keys to adjust, and then press the enter  key when finished to save. To adjust the number of strokes, press the down  arrow key, and then press the enter  key. Press the up / down   arrow keys to adjust, and then press the enter  key when finished to save. Press the enter  key one final time to go back to the main screen.

Duo Mode
USE ARROWS TO SELECT
A = Dispense
B = Dispense
PRESS 'ENTER' TO ADJUST



Main Screen (Pump A in Continuous mode & Pump B in Dispense mode): Speed adjust from external source

Duo Mode
USE ARROWS TO SELECT
A = Continuous
B = Dispense
PRESS 'ENTER' TO ADJUST



Press the up / down   arrow keys, then the enter  key to adjust the desired pump

A = Continuous
USE 'ENTER' WHEN FINISHED
Speed = 200 rpm
Control = Keypad
USE ARROWS TO ADJUST

To adjust the speed, press the up / down   arrow keys until the desired speed is set. Notice how the speed immediately begins to adjust. To save, press the enter  key when finished to save. The unit returns to main screen.

Duo Mode
USE ARROWS TO SELECT
A = Continuous
B = Dispense
PRESS 'ENTER' TO ADJUST

If the unit has been configured for other forms of speed control other than Keypad, then the speed can only be set by that type of control. For example, if the speed control is set for 0-5 V, then the following screen will be seen.

A = Continuous
WAITING FOR START KEY
Analog = 200 rpm
Control = 0-5 v.

Analog Input Connector and Specifications

The PDS100 incorporates a simple screwless (spring loaded) terminal strip (see figure 6) for easy wire (22 to 14 AWG) connection to an external control source such as a PLC. It is recommended that a DIN wire ferrule be used (See figure 5).

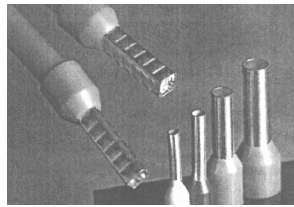

Figure 5
Wire Ferrule

Analog / Switch Input Terminal Strip

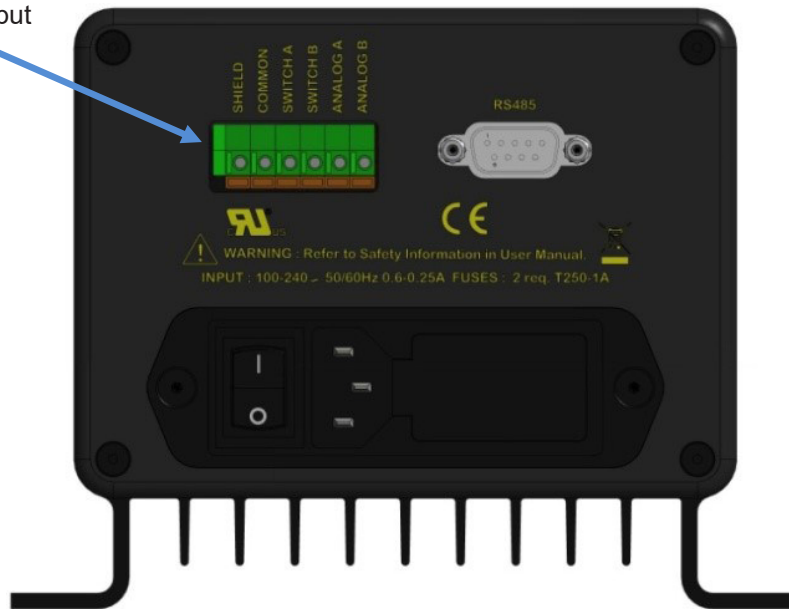

Figure 6
Analog Pump Control Connector (Rear Panel)

Signal	Description
Shield	Cable shield (terminate one end only)
Common	Ground
Switch A	Activates Prime, Purge and Start for Pump A when connected to Common and configured as such (TTL open collector or dry contact)
Switch B	Activates Prime, Purge and Start for Pump B when connected to Common and configured as such (TTL open collector or dry contact)
Analog A	Controls the speed of Pump A via an external voltage or current when configured as such (See Note 4 – Page 12)
Analog B	Controls the speed of Pump B via an external voltage or current when configured as such (See Note 4 – Page 12)

Table 1
Analog / Switch Input Connector

Analog Input Connector and Specifications (cont'd)

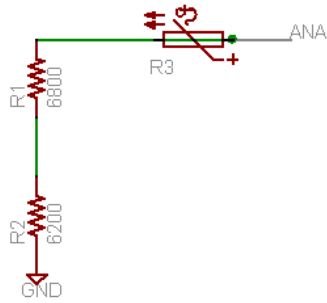

Figure 7
Input Resistance Schematic (Analog input: 0 – 5 VDC or 0 – 10 VDC)

	RPM		4 - 20 (mA) Input Resistance 490 ohms (Note 1,3,4)		0 - 5 (VDC) (Note 1,2,4)		0.5 - 10 (VDC) (Note 1 2,4)		Analog Input		
	Min	Max	Min	Max	Min	Max	Min	Max	4 - 20 mA	0 - 5 VDC	0 - 10 VDC
Standard H Pump		750							See Waveforms 1 to 9		
Standard Q Pump	6	600	1.6	20	0.2	5	0.2	10			
Standard STQP Pump		700									

Table 2
Input Voltage / Current Versus RPM

NOTES

- Note 1:** Maximum current is reduced provided control method is set according to actual input method (ie 0 – 5 VDC or 0 – 10 VDC). If desired control method is set for “4–20mA” but a 0 – 5 VDC or 0 – 10 VDC is applied the maximum current will be at its greatest.
- Note 2:** Absolute maximum input voltage is 10.8 VDC
- Note 3:** Absolute maximum current is 22 mA
- Note 4:** When start is set to “Analog”, it is important to switch voltage / current on only when above the minimum to properly start the pump(s). It is equally important to switch voltage off rather than slowly ramping the voltage / current down below the minimum. It is not recommended to gradually raise / lower the input voltage / current to start / stop the pump(s).

When start / stop is controlled via the analog input, the pump(s) will stop when the analog input goes below the minimum voltage / current. The pumps will run when the minimum voltage / current is reached and will run at the minimum speed.

RS485 Connector Pin, Command Set and Specifications

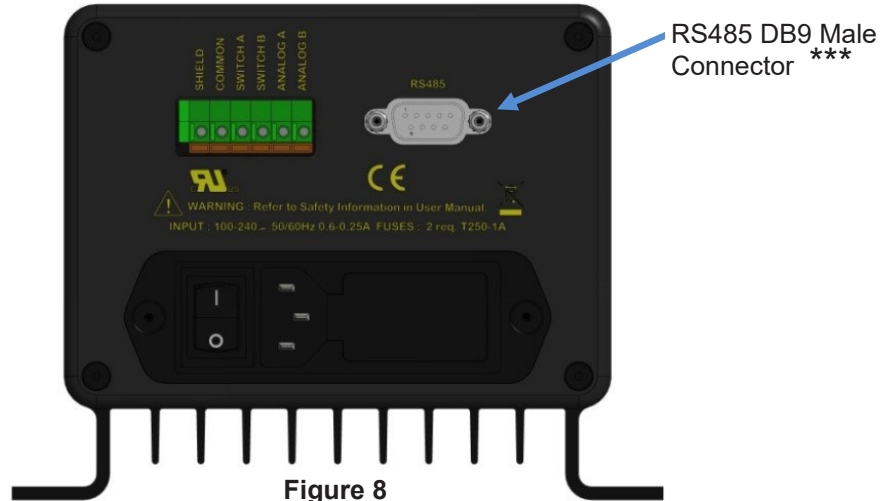

Figure 8
RS485 Control (Rear Panel)

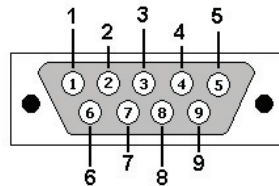

Figure 9
RS485 Control (Rear Panel)

(4 Wire)

(2 Wire)

Pin On DB9 Male Connector	Signal	EIA / TIA-485 Name
8	RXD0	A'
4	RXD1	B'
5***	TXD1	B
9	TXD0	A
1	Common	C C'

Pin On DB9 Male Connector	Signal	EIA / TIA-485 Name
5***	D1	B B'
9	D0	A A'
1	Common	C C'

Table 3
RS485 Control (Rear Panel)

PDS-100 follows the guidelines per **MODBUS over Serial Line protocol**

Port Settings

Baud Rate	19,200
Stop Bits	1
Data Bits	8
Parity	Even

*** Pin 5 also acts as an output when the PDS is NOT configured to communicate via RS485. The output uses the RS-485 transceiver as a general output. The output is used to indicate a stall which is active high (output high when pump stalls). The pin is rated to a maximum voltage of 14 VDC and a maximum current of 60 mA. With a 100 ohm load on pin 5 the nominal output is 2 VDC minimum.

Important: For all industrial environments, it is recommended that an isolation /surge protection adapter be used to protect the PDS100 from external high voltages (for example: Antaira UTS-401BK-SI.)

Note: PDS100 accommodates up to 31 addressable units



Command Mapping

Single bit read and write. Set bit to initiate action, PDS-100 will clear bit upon execution

- Coil 0 = "start" > Pump A – (all configurations except individual – individual pump A only)
- Coil 1 = "stop" > Pump A – (all configurations except individual – individual pump A only)
- Coil 2 = "start-2" > Pump B – (individual configuration only)
- Coil 3 = "stop-2" > Pump B – (individual configuration only)

Single bit status, read only

- Input 0 = "busy" > Pump A – (all configurations except individual – individual pump A only)
- Input 1 = "error" > Pump A – (all configurations except individual – individual pump A only)
- Input 2 = "busy-2" > Pump B – (individual configuration only)
- Input 3 = "error-2" > Pump B – (individual configuration only)

16 bit word read and write. Not allowed to change when pump is busy

- Holding Register 0 = "rpm" > Pump A
- Holding Register 1 = "stroke count" > Pump A
- Holding Register 2 = "rpm-2" > Pump B
- Holding Register 3 = "stroke count-2" > Pump B

16 bit word information read only

- Input Register 0 = "configuration" *see configuration table
- Input Register 1 = "operating mode" 0=continuous, 1=dispense
- Input Register 2 = "operating mode-2" 0=continuous, 1=dispense
- Input Register 3 = "error code" 0= no error, 1= error
- Input Register 4 = "error code-2" 0= no error, 1= error
- Input Register 5 = "minimum-speed"
- Input Register 6 = "maximum-speed"

Configuration Table

Drive	Code
Single (RH)	16384
Single (STH)	16385
Single (STQ)	16386
Single (STQP)	16387
Individual (RH)	49152
Individual (STH)	49153
Individual (STQ)	49154
Individual (STQP)	49155
In phase (RH)	49664
In phase (STH)	49665
In phase (STQ)	49666
In phase (STQP)	49667
Out of phase (RH)	50688
Out of phase (STH)	50689
Out of phase (STQ)	50690
Out of phase (STQP)	50691
Smooth (RH)	52736
Smooth (STH)	52737
Smooth (STQ)	52738
Smooth (STQP)	52739



Configuration Modes Screens



(Appears when Up  Arrow and Setup  Keys are held down while powering up unit)

The unit comes pre-configured as a Dual Individual system when purchased as a dual pump system. To configure the dual pump system for “In Phase” operation or “Out Phase” operation follow the procedure mentioned above to modify. If the unit supplied is a single pump system there is no need to change the configuration.

Possible drive configurations types supported (configured by factory):

1. **Single:** Single pump
- * 2. **Individual:** Two pumps that can be controlled independently
3. **In Phase:** Two pumps that are in phase with each other
4. **Out of Phase:** Two pumps that run 180 degrees out of phase for each other
5. **Smooth:** Requires factory calibrated pump drive assembly **Not covered in this manual.**

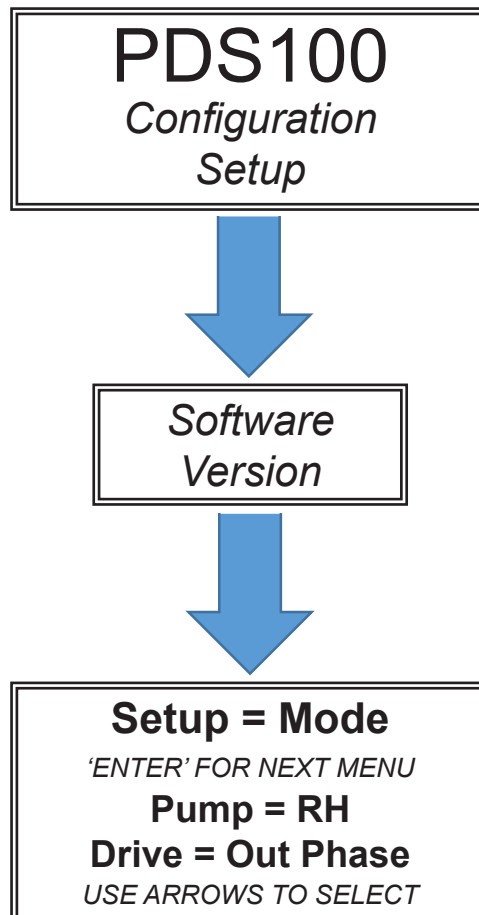

* Default Setting

The following screens will be seen when entering the configuration mode. The configuration mode can only be entered if the up  arrow key and setup  keys are held down while powering on the unit. After configuration selection is made, press **Setup** for changes to take effect.



Factory Restore

(Appears when Down  Arrow and Enter  Keys are held down while powering up unit)

Factory restore is available in the unlikely event the user is unable to recover from undesired settings made after the unit was first received. To reset the PDS100 back to factory default, **make sure power is off**. Press and hold down both the down  arrow key and enter  key and then apply power to the PDS100. Wait until the “Restore Factory Settings” screen appears, and then release the buttons. It is important to note that this cannot be undone at this point. If the PDS100 is equipped with only one pump and / or a pump other than the RH, it is important to now power the PDS100 down and follow the instructions on the previous page under “Configuration Mode Screens”. Once the unit has been properly configured correctly, the single pump will home. At this point the unit will need to be set up with the desired control settings as described throughout this manual.

The following screens will be seen when entering the Factory Restore mode.

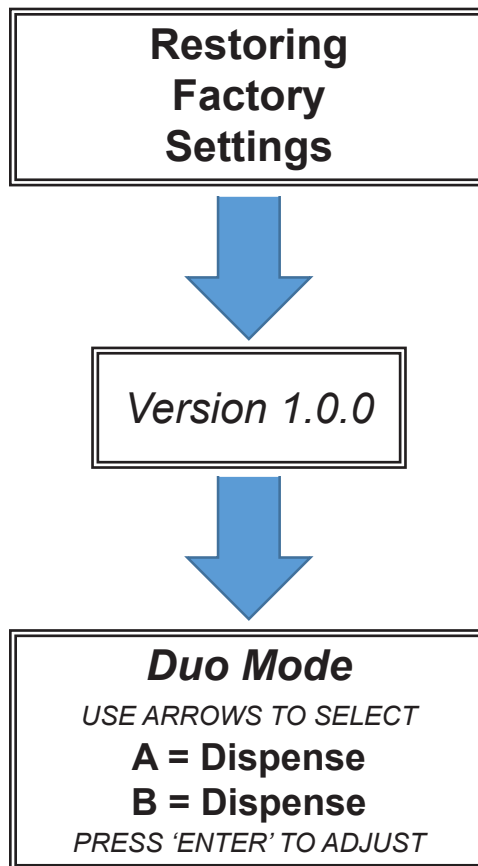

****** If the PDS is only equipped with one pump, and the menu “Version xxxx” appears, the next screen will show the screen below. Pump B does not exist, so it can never home. Follow the steps on the previous page to configure the PDS for “Drive = Single”.

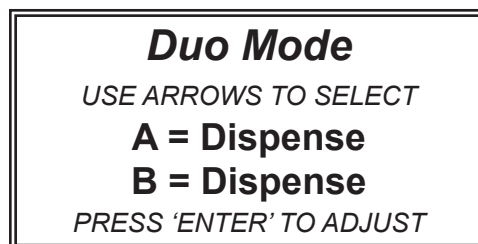

Table 4
Pump Operating Parameters

Pump Models	Piston Size	Speed (RPM)		Dispense (mL per rev)		Single Pump Flow Rate (mL/min)		Dual Independent Pumps (See Note 1)	
		Min	Max	Min	Max	Min Flow	Max Flow	Min Flow	Max Flow
STRH, STH	H00 (1/8")	6	750	0.003	0.025	0.0180	18.75	0.036	37.50
STRH, STH	H0 (3/16")	6	750	0.003	0.050	0.0180	37.50	0.036	75.00
STQP, STQ	Q0 (1/8")	6	600	0.004	0.080	0.0240	48.00	0.048	96.00
STRH, STH	H1 (1/4")	6	750	0.005	0.100	0.0300	75.00	0.06	150.00
STQP, STQ	Q1 (1/4")	6	600	0.016	0.320	0.0960	192.00	0.192	384.00
STQP, STQ	Q2 (3/8")	6	600	0.036	0.720	0.2160	432.00	0.432	864.00
STQP, STQ	Q3 (1/2")	6	600	0.064	1.280	0.3840	768.00	0.768	1536.00

Note 1: Flow Rates shown are minimum and maximum flow rates for 2 identical size pumps set at the same displacement and speed.

Note 2: STQP Pump s are only available in a single pump configuration

Dual Independent Pump Configuration Notes

- 1) Any combination of two (2) STRH or two (2) STH Pump Size and Displacement Settings
- 2) Any combination of two (2) STQ Pump Sizes and Displacement Settings. Pump displacement is factory calibrated.
- 3) To calculate total flow from a Dual Pump Configuration, calculate the output of each individual pump as follows:

$$\text{Total Flow} = (\text{Pump \#1 displacement} \times \text{Pump \#1 Speed}) + (\text{Pump \#2 displacement} \times \text{Pump \#2 Speed})$$
- 4) For PDS 100 Smooth-flow data, see separate chart.

