

## 2/2-way Solenoid Valve with servo diaphragm

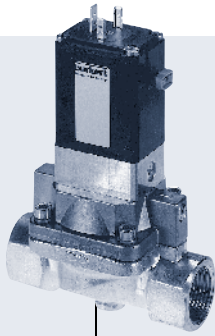

Type 5282 can be combined with...

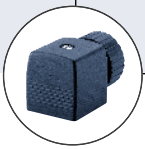

**Type 2508**  
Cable plug



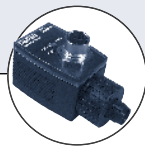

**Type 1078**  
Timer unit



**Type 2511**  
ASI cable plug



**Type 8600**  
Dosing control

- Pivoted armature pilot drive with emergency manual operation
- Media separated
- Circuit function can be modified
- Adjustable switching times (waterhammer-free)
- Threaded port or flange connections
- Approvals:     

The Type 5282 is a pilot-controlled normally closed solenoid valve with a servo-diaphragm, media separated, for universal use with liquid and gaseous media corresponding to the material resistance. As standard, the 3-way pivoted armature pilot drive has an emergency manual operation. The closing and opening times are continuously adjustable.

Power consumption		
Inrush	Hold	
AC [VA]	AC [VA/W]	DC [W]
24	14/8	8

A differential pressure of 7 PSI (0.5 bar) is required to open the full orifice. The response times can be changed by turning the restrictor screws (in the body cover).

Technical data	
<b>Orifice</b>	1/2" - 2" (DN 13 - 65 mm)
<b>Body material</b>	Threaded port Flange
	Brass, stainless steel 1.4581 Stainless steel 1.4541
<b>Seal material</b>	NBR, FKM, EPDM (on request)
<b>Media</b>	NBR EPDM FKM
	Neutral media, such as compressed air, water, hydraulic oil Oil and fat-free media, incl. alkalis, hot water Hot air, oxygen, per-solutions, hot oil
<b>Media temperature</b>	NBR EPDM FKM
	14°F to 194°F (-10°C to +90°C) -22°F to 194°F (-30°C to +90°C) 32°F to 194°F (0°C to +90°C)
<b>Ambient temperature</b>	Max. 131°F (+55°C)
<b>Voltage tolerance</b>	±10%
<b>Duty cycle</b>	100% continuous rating
<b>Electrical connection</b>	Tag connector acc. DIN 43650 Form A for cable plug Type 2508
<b>Protection class</b>	IP 65 with cable plug
<b>Installation</b>	As required, preferably with actuator upright

\* See our HazEx™ guide for ATEX and for FM Class 1, Div. 1 versions

Solenoid valve dimensions

Dimensions [mm]								
Threaded port						Flange port		
DN	D	B1	E1	F	L1	B2	G	L2
13	NPT 1/2	123.0	40	14	65	-	-	-
20	NPT 3/4	131.0	60	16	100	-	-	-
25	NPT 1	141.0	70	18	115	184.5	120	160
32	NPT 1 1/4	147.0	85	20	126	192.0	140	180
40	NPT 1 1/2	156.0	85	22	126	201.0	150	200
50	NPT 2	177.5	115	24	164	225.0	165	230
65	NPT 2 1/2	185.0	115	27	180	-	-	-

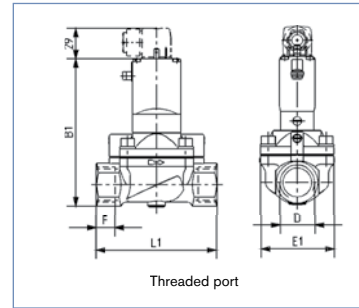

Threaded port

Ordering chart for valves (other versions on request) UL recognized / CSA/ CE  
Manual override, supplied without cable plug, different seal materials on request

Circuit function	Orifice [mm]	Port connection [NPT]	Cv value water [GPM]	Nominal pressure [psi]	Voltage/frequency [V/Hz]	Item no. Seal material NBR Seal Brass Body	Item no. Seal material FKM Seal Stainless Steel Body
<b>A</b> 2/2-way valve, NC 	13.0 (Brass) 20.0 (Stainless steel)	NPT 1/2	4.7	2.8 - 145	024/DC	456 890	456 914
					024/50-60	456 891	456 915
					120/50-60	456 892	456 916
					240/50-60	456 893	456 917
or <b>B</b> 2/2-way valve, NO 	20.0	NPT 3/4	5.8	2.8 - 145	024/DC	456 894	456 918
					024/50-60	456 895	456 919
					120/50-60	456 896	456 920
					240/50-60	456 897	456 921
	25.0	NPT 1	11.7	2.8 - 145	024/DC	456 898	456 922
					024/50-60	456 899	456 923
					120/50-60	456 900	456 924
					240/50-60	456 901	456 925
	32.0	NPT 1 1/4	23.5	2.8 - 145	024/DC	456 902	456 926
					024/50-60	456 903	456 927
					120/50-60	456 904	456 928
					240/50-60	456 905	456 929
	40.0	NPT 1 1/2	23.5	2.8 - 145	024/DC	456 906	456 930
					024/50-60	456 907	456 931
					120/50-60	456 908	56 932
					240/50-60	456 909	456 933
50.0	NPT 2	47.0	2.8 - 145	024/DC	456 910	456 934	
				024/50-60	456 911	456 935	
				120/50-60	456 912	456 936	
				240/50-60	456 913	456 937	

Delivered as circuit function A  
Change to the circuit function B by turning the pilot drive through 180°

Mounting instructions:

Arrangement of the pilot control

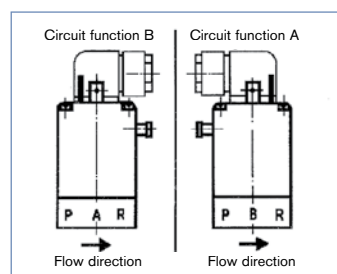

**Solenoid valve ordering chart**

**Ordering chart for valves** (other versions on request) UL listed / FM class / Division 2 / CSA / CE  
 Manual override, supplied with cable plug type 2509, different seal materials on request

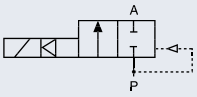
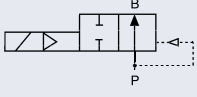
Circuit function	Orifice [mm]	Port connection [NPT]	Cv value water [GPM]	Pressure range [psi]	Voltage/frequency [V/Hz]	Item no. Threaded port NBR Brass	Item no. Threaded port FKM Stainless Steel
<b>A</b> 2/2-way valve NC 	13.0 (Brass)	NPT 1/2	4.7	2.8 - 145	024/DC	457 870	457 894
	20.0 (Stainless steel)				024/50-60	457 871	457 895
					120/50-60	457 872	457 896
					240/50-60	457 873	457 897
or  <b>B</b> 2/2-way valve NO 	20.0	NPT 3/4	5.8	2.8 - 145	024/DC	457 874	457 898
	25.0				024/50-60	457 875	457 899
					120/50-60	457 876	457 900
					240/50-60	457 877	457 901
32.0	NPT 1	11.7	2.8 - 145	024/DC	457 878	457 902	
				024/50-60	457 879	457 903	
				120/50-60	457 880	457 904	
				240/50-60	457 881	457 905	
40.0	NPT 1 1/4	23.5	2.8 - 145	024/DC	457 882	457 906	
				024/50-60	457 883	457 907	
				120/50-60	457 884	457 908	
				240/50-60	457 885	457 909	
50.0	NPT 1 1/2	23.5	2.8 - 145	024/DC	457 886	457 910	
				024/50-60	457 887	457 911	
				120/50-60	457 888	457 912	
				240/50-60	457 889	457 913	
50.0	NPT 2	47.0	2.8 - 145	024/DC	457 890	457 914	
				024/50-60	457 891	457 915	
				120/50-60	457 892	457 916	
				240/50-60	457 893	457 917	

Delivered as circuit function A

Change to circuit function B by turning the pilot drive through 180°.

**NOTE:** All UL listed valves include type 2509 1/2" conduit cable plug

DTS 1000082431 EN Version: - Status: RL (released | freigegeben | validé) printed: 13.08.2008

**Type 2509 Dimensions [mm]**

